

# Vinyl Real Glass Block Windows

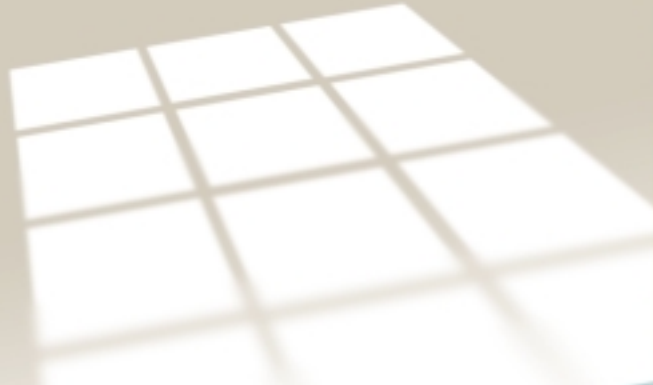

Voted  
**Highest  
Quality**



by the National Association of  
Home Builders Survey and  
Builder Magazine

**Real Glass and Performance in a sleek new package**

*Why have a plastic block window, when you can have the beauty and brilliance of real glass block in a light, easy to install package. Demand Vinyl Wrap® **real** glass block windows!*

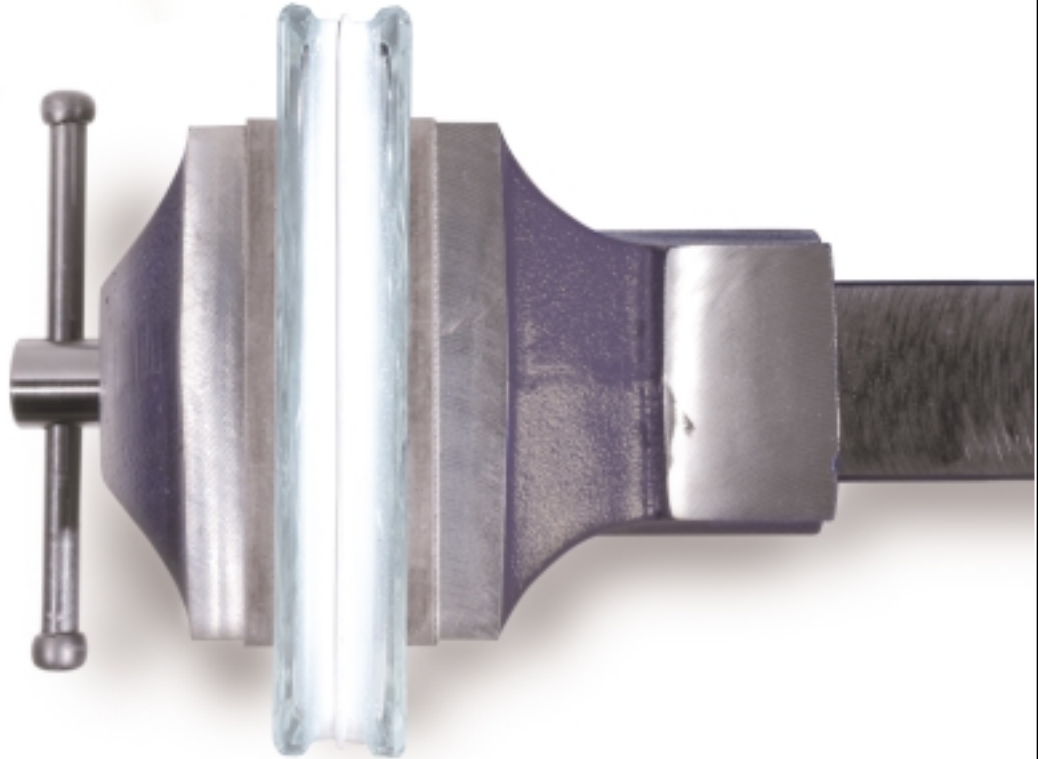

## 2 INCH STOCK SERIES

(30% Lighter and Thinner)

FRAME COLORS • White • Almond

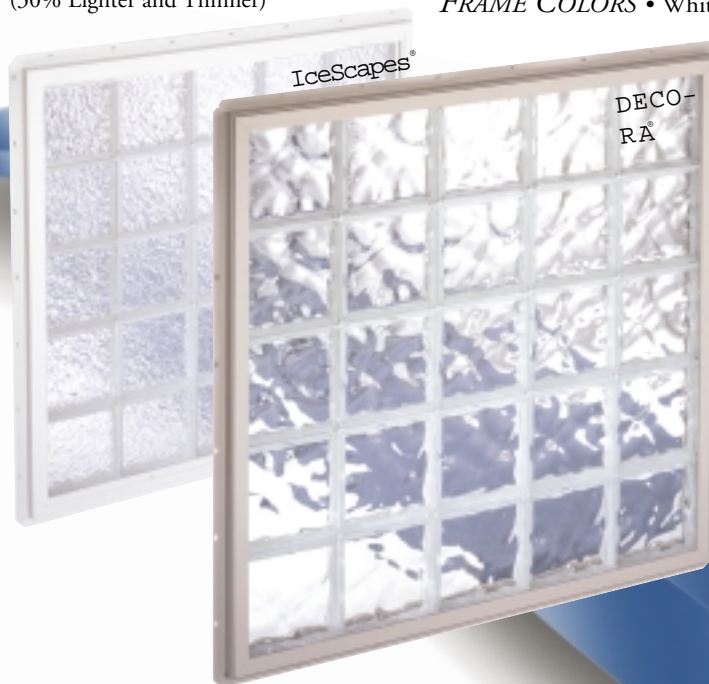

Block Unit Sizes Available

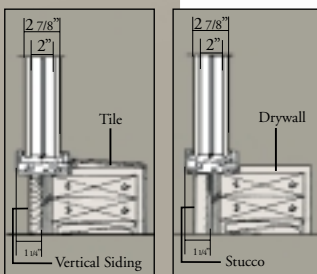
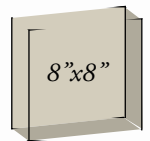

*Our sleek new vinyl window profile gives you more glass and less frame.*

*Our goals are simple. We simply want to exceed your expectations.*

- Privacy • Quality • Durability • Maximum Natural Light
- Ease of Maintenance • Easy Installation
- Beauty of REAL GLASS BLOCK



## 3 INCH CUSTOM SERIES

Block Unit Sizes Available

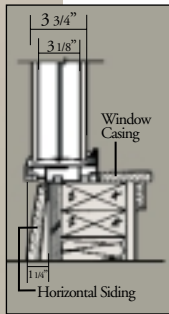
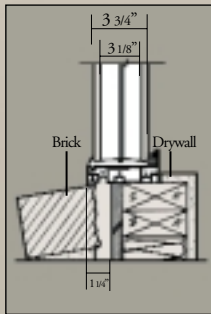
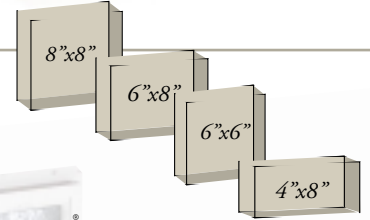

### RETROFITTING

Made easy by combining different size blocks that adjust to almost any size opening



# 4 INCH CUSTOM SERIES

Block Unit Sizes Available

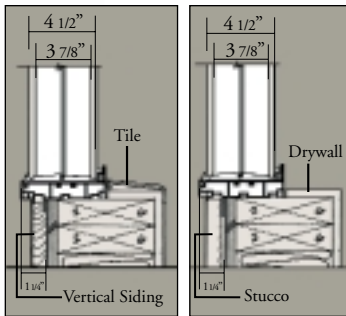
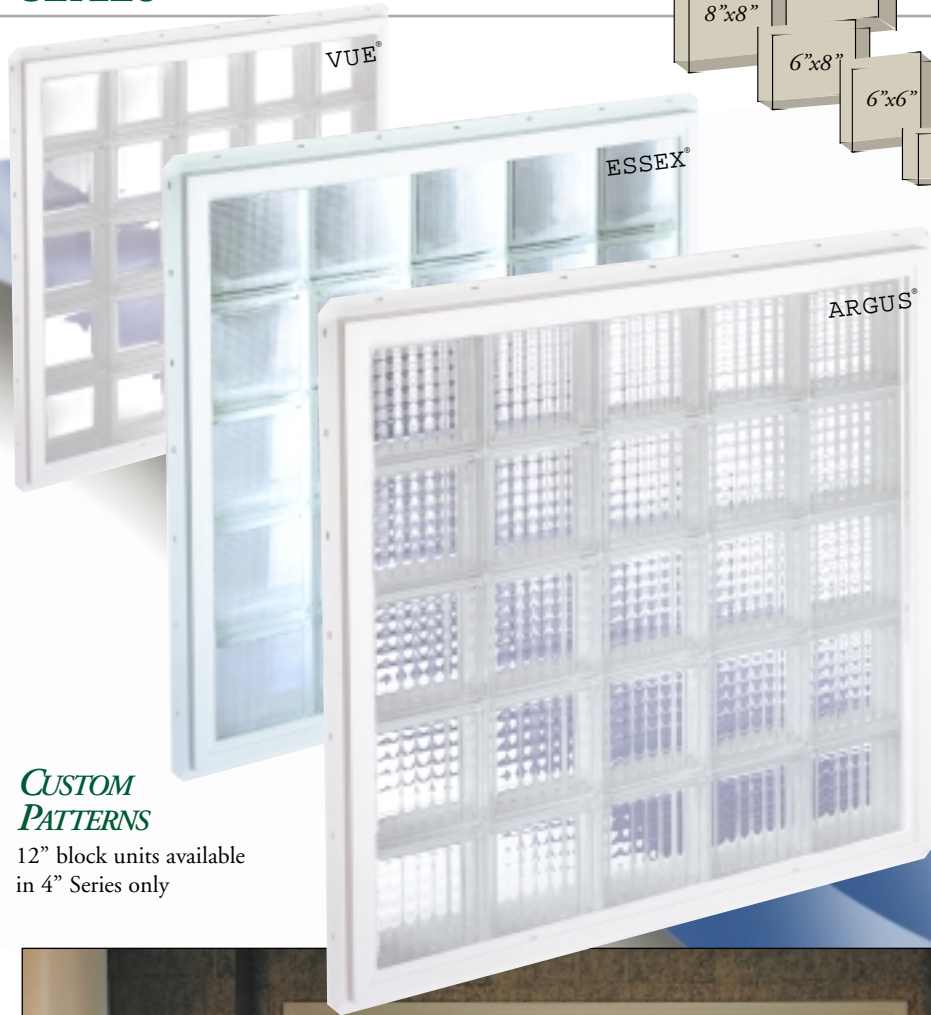
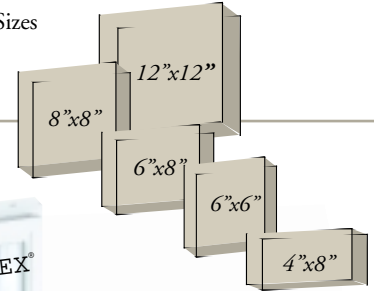

## CUSTOM PATTERNS

12" block units available in 4" Series only



## *FRESH AIR SLIDERS*

Check with local manufacturer for availability

*Top off that tub window with a Fresh Air Slider available in clear or obscure glass. Some limitations apply call for availability.*



## *STAIR STEP SHAPES*

*Check with local manufacturer for availability*

*Customize your window design with Stair Step window shapes or mixed patterns and block sizes*



## *CUSTOM COLOR VINYL COATINGS*

*A wide variety of custom colors available*

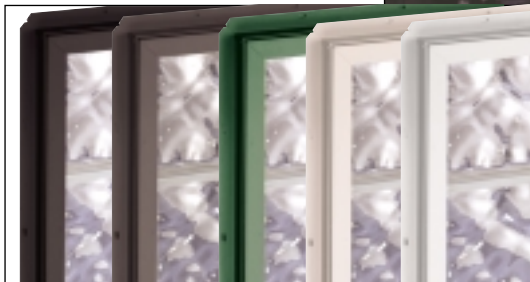



# P E R F O R M A N C E

## F O R A L I F E T I M E



**THERMAL PERFORMANCE** Heat & Cold  
Thermal efficiency test varied upon block thickness from .42 up to .52. Test standard: NFRC

**IMPACT**  
400 Foot pound testing resulted in no damage  
Test Standard: CPSC 16 CFR 1201 Category

**WATER INFILTRATION**  
Performance after structural test @ 7.5 psf resulted in no infiltration.  
Test Standard: ASTM & 547-96

**FORCED ENTRY**  
Several forced entry attempts results in no window failure  
Test standard: CMBSO / CAWM301-90, forced entry resistance

**WIND LOAD** Hurricane  
3" System tested up to 322 mile per hour winds.  
Test Standard: AAMA / NWDA 101/I.S. 2-97

**MISSILE IMPACT** 8' long 2 x 4 test  
Large missile impact and coastal structure loads are achieved with 4" system only using thick-set Glass Block units

\*All vinyl wrap systems are TDI approved for inland zone 1 and 2



## ENGINEERED

by a team of fenestration experts to withstand the most extreme of conditions. Our patented vinyl stack spacing® system outperforms other real glass block windows that have no integral spacer and rely only on a thin bead of silicone to assemble and seal between glass blocks.



Glass block pattern names are property of Pittsburgh Corning Corporation.

	2" System	3" System	4" System
<b>Thermal R-Value</b>	1.92	2.13	2.38
<b>Thermal U-Value</b>	.52	.47	.42
<b>Sound Transmission</b>	26	31	39
<b>Safety 400lb Impact</b>	passed	passed	passed
<b>Wind Load pounds per square foot</b>	75psf	260psf	260psf
<b>Weight per square foot</b>	9.8	13.	17.

## Rough Opening Chart

Based on Using 8" x 8" Glass Block Units

Stock 2" Thick

Custom 3" & 4" Thick

Number of Blocks	Rough Opening
1	10"
2	17 3/4"
3	25 3/4"
4	33 1/2"
5	41 1/4"
6	49 1/4"
7	57"
8	65"
9	72 3/4"
10	80 3/4"

Number of Blocks	Rough Opening
1	10 1/2"
2	18"
3	26"
4	33 3/4"
5	41 3/4"
6	49 1/2"
7	57 1/2"
8	65 1/4"
9	73 1/4"
10	81"

LOCAL DEALER

## 10 YEAR LIMITED WARRANTY

Vinyl Wrap Glass Block windows are guaranteed and warranted by independent fabricators for a period of 10 years - to be free from defect in materials, workmanship and performance. Limitations and conditions available upon request.